

# TrailerSaver TS3 Owners Manual

Version 3.2



Hensley Mfg., Inc.  
1097 S State Rd  
Davison, MI 48423  
800-410-6580  
[www.TRAILERSAVER.com](http://www.TRAILERSAVER.com)

## Table of Contents

1	Warranty Provisions.....	5
1.1	What Is Covered.....	5
1.2	What Is Not Covered .....	5
2	TrailerSaver Parts Identified .....	7
2.1	TrailerSaver Replacement Parts List .....	8
3	Accessories List.....	12
3.1	TS3 .....	12
3.2	SAVERSLIDE & SMARTAIR .....	12
3.3	Tools.....	13
3.3.1	TS3.....	13
4	INSTALLATION .....	14
4.1	TS3 .....	14
4.1.1	Installation of Rails.....	15
4.1.2	Proper Inflation/Deflation .....	15
4.2	Compressor Kits.....	16
4.2.1	Installation/Operation of Compressor with Dash Panel Controller .....	17
4.2.2	Operation of the SmartAir Inflation System.....	19
4.2.3	Compressor with Built In Switch .....	21
4.3	Installation of the TS3 Spacer Kit.....	22
4.4	SaverSlide/SimpleSlide Installation .....	24
4.5	Gooseneck Adapter Installation .....	25
5	Standard Hooking and Unhooking Procedures .....	26
5.1	Hooking Up.....	26
5.2	Unhooking .....	27
5.3	Non Grease Lube Plates.....	28
6	SLIDER OPERATION.....	29
6.1	SaverSlide Operation.....	29
6.1.1	SaverSlide Pneumatic Connections.....	31
6.1.2	SaverSlide Electronics Connections .....	32
6.2	SimpleSlide Operation.....	33
7	Maintenance.....	34
8	TROUBLESHOOTING .....	36
8.1	General Troubleshooting.....	36
8.1.1	I cannot get the TrailerSaver to lock around the kingpin. ....	36
8.1.2	The TrailerSaver will not hold air pressure. ....	36
8.1.3	I hear a squeak from the hitch. ....	36
8.1.4	I cannot get the handle from the 10 o'clock position to the 9 o'clock position.....	37
8.1.5	The TS3 will not fit into the rails.....	37
8.1.6	I am getting a rough ride. ....	37
8.2	For SmartAir and SaverSlide.....	37
8.2.1	When I hook up to the trailer the compressor does not activate. ....	37
8.3	SaverSlide .....	38
8.3.1	When I press the key fob remote, the slider locks do not activate. ....	38

8.3.2	I have power to the 2-prong connector but the hitch does not inflate.....	38
9	Accessories.....	39
10	Maintenance Log.....	40

## Tables / Figures

Figure 2.1	TS3 on Rails.....	7
Figure 2.2	SaverSlide.....	7
Figure 3.1	Handle(PN 45512) / Hook(PN 45514) Extension.....	12
Figure 3.2	Hitch pins (PN 46241 x 4).....	12
Figure 3.3	Key fob remotes (PN see Note below).....	12
Figure 3.4	7-Way power harness (PN 41010).....	12
Figure 3.5	Torque wrench with 3/4" socket & grease gun (PN N/A).....	13
Figure 4.1	Insert hitch pins (PN 46241).....	14
Figure 4.2	TS3 equipped with Spacer Kit (2"-PN 46250, 3"-PN 46350).....	14
Figure 4.3	Rail installation kit (PN 45609).....	15
Figure 4.4	Super Rails (PN N/A).....	15
Figure 4.5	White hitch mark.....	16
Figure 4.6	Inflating to the white mark.....	16
Figure 4.7	Schrader valve (PN 45046).....	16
Figure 4.8	Dash Panel (PN 45406).....	17
Figure 4.9	Built in switch (PN 45401).....	17
Figure 4.10	Smart Air (PN N/A).....	17
Figure 4.11	7-Way power harness (PN 41010).....	17
Figure 4.12	Optional Compressor and Dash panel control (PN 45400).....	17
Figure 4.13	Dash Panel (PN 45406).....	18
Figure 4.14	Molded two-prong connector.....	18
Figure 4.15	Strip the outer jacket.....	18
Figure 4.16	Strip 1/4" insulation.....	18
Figure 4.17	Insert into tee fitting (PN 49212).....	19
Figure 4.18	Dash Panel (PN 45406).....	19
Figure 4.19	7-Way Plug with 12VDC (PN 41010).....	20
Figure 4.20	Two wire connector.....	20
Figure 4.21	Inflation Line.....	20
Figure 4.22	SmartAir Level System (PN N/A).....	20
Figure 4.23	Manual Switch (PN 45421).....	21
Figure 4.24	Riser Kit (2"-PN 46250, 3"-PN 46350).....	22
Figure 4.25	Welded Leg.....	22
Figure 4.26	Rounded Edge Up Long Weld Faces Outside.....	22
Figure 4.27	Placement of 1/2" and 3/8" thick legs.....	22
Figure 4.28	Riser installed In front of Hitch.....	23
Figure 4.29	Placed on each Corner of the hitch.....	23
Figure 4.30	Bolt head on the riser leg.....	23
Figure 4.31	Cross Support.....	23
Figure 4.32	Welded Leg.....	23
Figure 4.33	Riser Leg.....	23
Figure 4.34	Slider frame Bolts.....	24
Figure 4.35	7-Way power Harness (PN 41010).....	24
Figure 4.36	Tee Fitting (PN 49212).....	24
Figure 4.37	Slider Frame leg.....	25
Figure 4.38	Gooseneck Installation (PN 45540).....	25

Figure 5.1 Handle(PN 45512) / Hook(PN 45514) Extension .....	26
Figure 5.2 Eight o'clock Position .....	26
Figure 5.3 Nine o'clock Position .....	26
Figure 5.4 Ten o'clock Position .....	26
Figure 5.5 Before Hooking up (Nine o'clock).....	26
Figure 5.6 Retainer Pin view at Eight o'clock .....	26
Figure 5.7 Padlock into Eight o'clock position .....	26
Figure 5.8 Ten o'clock position (note red mark is exposed) .....	28
Figure 5.9 Non Grease Lube Plates (PN 46242) .....	28
Figure 6.1 SaverSlide Operation .....	29
Figure 6.2 Locking Mechanism.....	29
Figure 6.3 Fuse(s) Location .....	30
Figure 6.4 SaverSlide Air Side Drawing .....	31
Figure 6.5 SaverSlide Electronics Board Image Top View .....	32
Figure 6.6 SaverSlide Electronics Board Image Side View .....	32
Figure 6.7 Handle(PN 45512) / Hook(PN 45514) Extension .....	33
Figure 6.8 Retaining Pin location .....	33
Figure 6.9 Locking mechanism.....	33
Figure 6.10 Turn tow vehicle position .....	33
Figure 7.1 Grease every 4,000 miles .....	34
Figure 7.2 Check pivot bolt wear (PN 44031) .....	34
Figure 7.3 Fore/Aft Pivot Pins .....	34
Figure 7.4 Jaw Pivot pins location.....	34
Figure 7.5 Tilt spring location (PN 44009) .....	35
Figure 7.6 Jaw mechanism .....	35
Figure 8.1 Fittings check with soapy water (PN 45003, PN 49209, PN 45554 and PN 49212) ....	36
Figure 8.2 Lubricate fore and aft pivot pins .....	36
Figure 8.3 Fuse Location.....	38
Figure 8.4 SmartAir Level.....	38
Figure 8.5 Remote control fuse location .....	38
Figure 8.6 Inline fuse location.....	38
Figure 8.7 Wire loom fuse location .....	38
Figure 9.1 Vinyl Hitch Cover (PN 45571) .....	39
Figure 9.2 Gooseneck adapter ball (PN 45540) .....	39
Figure 9.3 Emergency Kit (PN 45600).....	39
Figure 9.4 Lube Plates (PN 46242) .....	39
Figure 9.5 Ultimate Tire Chock (PN 40050) .....	39

## 1 Warranty Provisions

The TrailerSaver hitch comes standard with a 3-year warranty on everything except the air springs and the optional 12 volt air compressor or related accessories, both which carry a 1-year warranty from their manufacturer.

SmartAir: Manufacturers' limited lifetime warranty for air springs.

<b>NOTE: IMPORTANT</b>
<b>Hensley Mfg., Inc. is not responsible for and will not compensate for lost time, vacation, or wages if a hitch is inoperable or requires repair.</b>

### 1.1 What Is Covered

The warranty period begins on the date of purchase.

The warranty is limited to the original purchaser of the TrailerSaver hitch and is non-transferable.

This warranty covers repair or replacement to any TrailerSaver part that is defective in materials or workmanship under normal use.

Warranty items must be returned to Hensley Mfg., Inc. for inspection.

Customer is responsible for all freight charges associated with warranty work.

### 1.2 What Is Not Covered

Items added, changed, or modified after the unit left the possession of Hensley Mfg., Inc.

Any use of the TrailerSaver for rental or other commercial purposes.

Normal wear and usage, such as fading or discoloration of painted parts.

Minor imperfections which do not affect the suitability of the TrailerSaver for its intended use.

Costs incurred as a result of the consumer's request to have repairs performed, or replacement of parts supplied by other than Hensley Mfg., Inc. without proper authorization or notification by Hensley Mfg., Inc.

This warranty does not apply to or cover any component which has its own warranty by its manufacturer.

**WARNING: IMPORTANT  
EXCEEDING MAXIMUM CAPACITY CREATES A SAFETY HAZARD.**

**TS3: 20,000 lb. max - Gross Trailer Weight Rating and 4,500 lb max pin weight**

If you have any warranty- related questions, please contact Hensley Mfg. at (800) 410-6580.

**For Warranty Exchanges ship all parts with Return Authorization # to:**

Hensley Mfg., Inc. RMA# \_\_\_\_\_  
378 Industrial Park Lane  
Hardinsburg, KY 40143

## 2 TrailerSaver Parts Identified

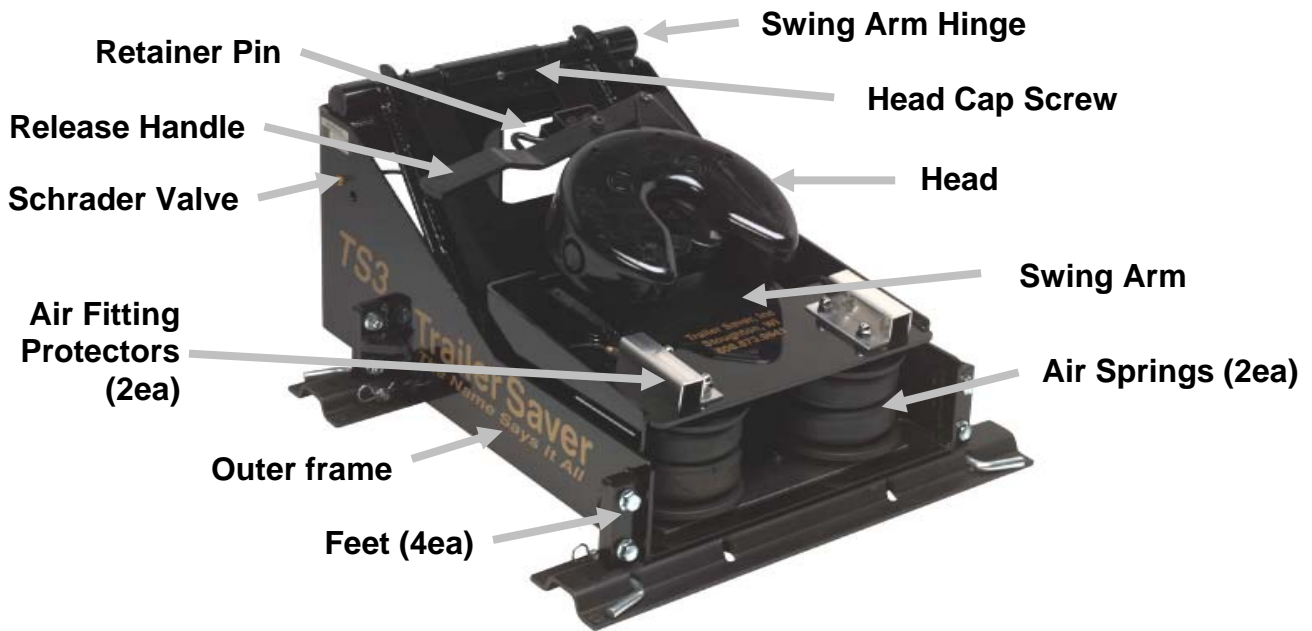


Figure 2.1 TS3 on Rails

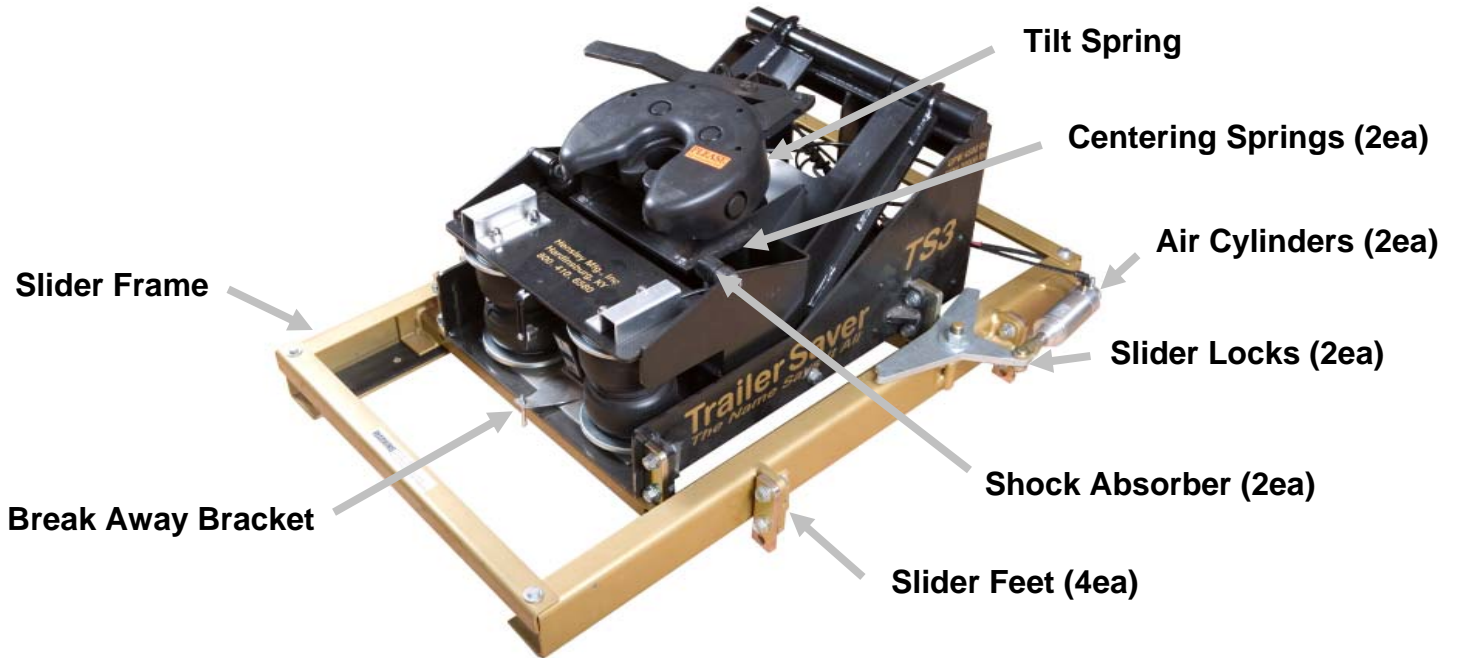




Figure 2.2 SaverSlide

## 2.1 TrailerSaver Replacement Parts List

	<b>Chrome Nut Cover 9/16"</b>	<b>45033</b>
	<b>1/2" Bent Hitch Pin 3" W/clip</b>	<b>46241</b>
	<b>Grease Fitting</b>	<b>41024</b>
	<b>Tilt Spring</b>	<b>44009</b>
	<b>Centering Spring</b>	<b>44012</b>
	<b>Pivot (Axis) Bolt</b>	<b>44031</b>
	<b>Air Fitting Protector</b>	<b>45030</b>
	<b>Union Tee (air fitting)</b>	<b>49212</b>
	<b>Swivel Elbow (air fitting)</b>	<b>49209</b>
	<b>Air Tubing</b>	<b>45036</b>
	<b>Complete Head</b>	<b>44001</b>
	<b>2" Spacer Kit (TS3)</b>	<b>46250</b>
	<b>3" Spacer Kit (TS3)</b>	<b>46350</b>



	<b>Air Spring</b>	<b>45006</b>
	<b>Pull Rite Adaptor (TS3)</b>	<b>46240</b>
	<b>Standard Rail Kit</b>	<b>45609</b>
	<b>Handle Extension (TS3)</b>	<b>45512</b>
	<b>Hook Extension (TS3)</b>	<b>45514</b>
	<b>Standard Feet Set (TS3)</b>	<b>46228</b>
	<b>Shock Absorber (TS3)</b>	<b>45001</b>
	<b>Break Away Bracket</b>	<b>45010</b>
	<b>Air Spring Roll Plate</b>	<b>45009</b>

	<p><b>Jaw Opening Spring</b></p>	<p><b>43057</b></p>
	<p><b>Compressor</b></p>	<p><b>45409</b></p>
	<p><b>7-Way Power Harness</b></p>	<p><b>41010</b></p>
	<p><b>Head Cap Screw</b></p>	<p><b>45012</b></p>
	<p><b>Electric Dash Control Gauge/Switch</b></p>	<p><b>45406</b></p>
	<p><b>Air Cylinder (SaverSlide Only)</b></p>	<p><b>43503</b></p>
	<p><b>Gooseneck adapter</b></p>	<p><b>45540</b></p>

	<p><b>Lube plate</b></p>	<p><b>46242</b></p>
	<p><b>TS3 vinyl cover</b></p>	<p><b>45571</b></p>
	<p><b>Emergency kit</b></p>	<p><b>45600</b></p>
	<p><b>Tire chocks</b></p>	<p><b>40050</b></p>
	<p><b>Compressor and dash panel control kit</b></p>	<p><b>45400</b></p>
	<p><b>Compressor kit with built in switch</b></p>	<p><b>45401</b></p>
	<p><b>Smart air System</b></p>	<p><b>178</b></p>

### 3 Accessories List

The TrailerSaver hitch is delivered fully assembled but every hitch should come with a few standard accessories:

- 1 - Owners Manual and Warranty Card
- 1 - Handle/Hook Extension (for extra reach when hooking and unhooking)



Figure 3.1 Handle(PN 45512) / Hook(PN 45514) Extension

#### 3.1 TS3



4 - hitch pins and cotter keys

Figure 3.2 Hitch pins (PN 46241 x 4)

#### 3.2 SAVERSLIDE & SMARTAIR

2- key fob remotes



Figure 3.3 Key fob remotes (PN see Note below)

1- 7-way Power Harness



Figure 3.4 7-Way power harness (PN 41010)

#### **NOTE: IMPORTANT**

2 Key fob remotes are only provided with the SaverSlide model. The entire electrical assembly must be replaced due to the transceiver and receiver pairing, in the event that the remotes are lost.

### 3.3 Tools

**NOTE: IMPORTANT**

Tools required for installation are minimal however you are required to torque a few bolts.

#### 3.3.1 TS3

Torque wrench with  $\frac{3}{4}$ " socket Grease Gun must be provided by the installer.



Figure 3.5 Torque wrench with  $\frac{3}{4}$ " socket & grease gun (PN N/A)

## 4 INSTALLATION

### 4.1 TS3



Figure 3.1 Standard top mounted slotted rail



Figure 3.2 Inserting rectangular feet centered

The TS3 is designed to fit into standard, top mounted, slotted rail systems. These would include such brands as Reese, Draw-Tite, Valley, Husky, Pull-Rite and RBW. If this is a retro-fit the first step is to remove existing hitch from the rails.

1. Loosen the two bolts in each leg of the TS3 and insert the rectangular feet into the appropriate rectangular slots on the rails.



Figure 4.1 Insert hitch pins (PN 46241)



Figure 4.2 TS3 equipped with Spacer Kit (2"-PN 46250, 3"-PN 46350)

2. Insert the hitch pins through the bottom of the rail and the hole on the feet at each corner of the TS3, making sure to use the retaining clips.
3. Tighten both bolts on each leg (8 total) to 50 ft-lbs. of torque each. Even if the TS3 fit right into the appropriate slots make sure the bolts are torqued as specified.
4. To achieve an operational height of 16" or 17" the TS3 will be fitted with a 2" or 3" spacer between the base of the hitch and the rails. The process for installation is the same with a spacer kit. The spacer incorporates 3

bolts for each corner (12 total), and these should be tightened to 50 ft-lbs.

#### 4.1.1 Installation of Rails



Figure 4.3 Rail installation kit (PN 45609)



Figure 4.4 Super Rails (PN N/A)

The TS3 is designed to be fastened, with the 4 supplied hitch pins, into a set of standard slotted 5<sup>th</sup> wheel rails; these would include: Reese, Drawtite, Valley, Husky, and RBW. These rails are standard and are not required to be installed by a TrailerSaver dealer. Most RV service centers or hitch installation facilities can install standard rails.

Many hitch installation facilities prefer to use a TS3 as a guide to ensure the hitch fits perfectly in the slots. An installer can use **any** hitch of the above-mentioned brands as a guide and, the TrailerSaver will fit in those slots. It is not necessary to have a TS3 to install the rails.

The basic measurements are 22" measuring from center of the rail to the opposite rail and two corresponding slots on each rail 20 ½" from each other.

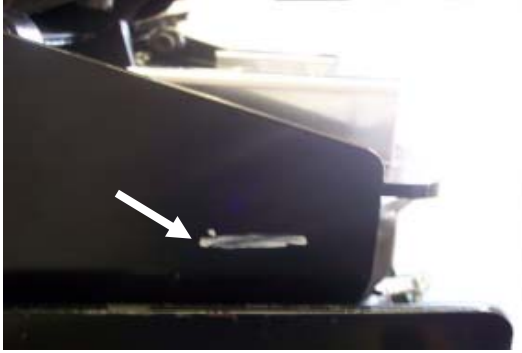
If you prefer a clean bed solution the TS3 can be fitted with adaptors, making it compatible with the Pull-Rite SuperRail 15.5K or 20.5K removable rail system.

#### 4.1.2 Proper Inflation/Deflation

The TS3 is equipped with a Schrader valve to manually inflate and deflate the air springs to the appropriate level.

A handheld air pump or small 12VDC air compressor are adequate for inflating the hitch. The TS3 is not to be inflated to a specified air pressure but to a specific level. **Do not inflate to greater than 100 PSI!** Follow these steps for proper inflation:

<b>WARNING:</b>	<b>IMPORTANT</b>
<b>Do not inflate to greater than 100 PSI!</b>	



**Figure 4.5 White hitch mark**



**Figure 4.6 Inflating to the white mark**

5. Locate the white level mark on the side of the hitch. This line is located on the same side as the Schrader valve. If this mark happens to fade or rub off, a new line can be created at a reference point 1 1/2" up from the bottom of the swing arm.
6. Hook up to the trailer without inflating the hitch and lift trailer stabilizer jacks allowing 100% of the pin weight to rest on the hitch. *See page 26 for hook-up procedures.*
7. Begin inflating until the white mark just clears the outer frame of the hitch. This level is just a guide and the air pressure can be increased or decreased from this point to tailor the ride. As a general rule, avoid inflating to more than 1/2" above level indicator. If the TS3 is inflated to below the level indicator the hitch may bottom out.



**Figure 4.7 Schrader valve (PN 45046)**

The TS3 can be deflated using the Schrader valve by depressing the stem core of the valve, allowing air to escape the air springs.

## 4.2 Compressor Kits

If the TS3 is ordered with one of the optional air compressor kits, the 12 v. compressor will be pre-installed in the base of the hitch. Hensley Mfg. offers three different options for controlling the air: A. dash panel control, B. built in



switch, and C. SmartAir. The built in switch and SmartAir options require no installation.



**Figure 4.8 Dash Panel (PN 45406)**



**Figure 4.9 Built in switch (PN 45401)**



**Figure 4.10 Smart Air (PN N/A)**

#### DASH CONTROL PARTS LIST:

- 20'- 1/4" vinyl air tube
- 1- electric gauge panel assembly
- 1- air compressor
- 3- thread cutting bolts
- 15'- 16/2 wire(one end has molded connector attached)
- PTC air line Tee fitting (non DOT)
- 2- Machine screws
- 2- Spade connectors



**Figure 4.11 7-Way power harness (PN 41010)**



**Figure 4.12 Optional Compressor and Dash panel control (PN 45400)**

#### **NOTE: IMPORTANT**

The built-in switch and Smart air options are shipped fully installed and power harness is packaged inside the hitch. (See page 6 parts list)

#### **4.2.1 Installation/Operation of Compressor with Dash Panel Controller**

A TS3 purchased with the dash panel control option will already have the 12VDC compressor bolted into the appropriate location inside the hitch and will be fitted

to the airbags. The portion of the compressor kit that will require installation involves the following steps:

**NOTE: IMPORTANT**

The molded connector that plugs into the compressor has different color wires than the supplied length of 16/2 wire it is connected to.

The molded connector has a red and brown wire. Red is 12VDC and brown is ground. The supplied wire has black and white. The black is 12VDC and white is ground.



**Figure 4.13 Dash Panel (PN 45406)**



**Figure 4.14 Molded two-prong connector**

1. Mount the electric gauge assembly in the cab where it can be easily accessed by the driver and preferably reached from outside the vehicle.



**Figure 4.15 Strip the outer jacket**



**Figure 4.16 Strip ¼" insulation**

2. Plug in the molded two-prong connector into the compressor and locate a path to route the supplied wire to the cab controller switch. A common installation would involve routing the wire under the bed of the truck.
3. After the correct length of wire to the switch has been determined, strip the outer jacket of the unfinished end of the supplied cable. Now cut the black wire at the cab switch.
4. Strip ¼" of insulation from both ends of the black wire at the cut and crimp spade connectors on both.
5. Insert both spade connectors on either prong located on the back of the controller switch.

6. Route the remainder of the black wire from the back of the controller to a reliable 12v power source. This power source should be fused at 20 amps.
7. Connect the white wire to a reliable ground on the vehicle. Do not ground to a location that may corrode later. The best ground source is directly to the battery on the truck.



**Figure 4.17 Insert into tee fitting (PN 49212)**



**Figure 4.18 Dash Panel (PN 45406)**

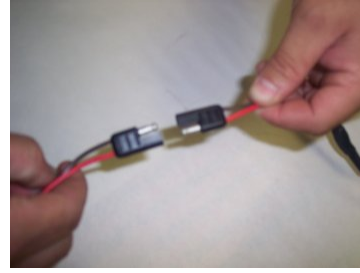
8. Insert the ¼" air tube into the open tee fitting inside the hitch. If the compressor was ordered with the hitch, this will be the only open air fitting.
9. Route air tube to the controller trim excess and insert into the open air fitting on the back of the controller/gauge.
10. Test the controller by depressing the toggle switch to activate the compressor. The gauge should indicate an increase in pressure as the compressor inflates the air springs.
11. Follow procedures for standard inflation on page 15 and make note of the air pressure when the level mark is visible. If the hitch is loaded to a consistent pin weight, simply inflate the hitch to the noted air pressure. If hooked to a different trailer, be sure the hitch is inflated to the level indicator.
12. To let air out of the hitch, press the small round button located just beneath the toggle switch on the controller.
13. To remove the hitch, unplug the supplied wire from the molded connector at the hitch and disconnect the ¼ air tube from the tee.

#### **4.2.2 Operation of the SmartAir Inflation System**

For proper operation of SmartAir, check with the trailer or truck dealer to ensure the 12VDC + pin of the 7-way plug is powered at the fuse box of the truck. For troubleshooting, keep a 12VDC test light with the hitch at all times.



**Figure 4.19 7-Way Plug with 12VDC (PN 41010)**



**Figure 4.20 Two wire connector**

1. Plug the supplied power harness into your truck's 7-way plug and your trailer plug will now insert into this pigtail.
2. Route the 2 wire plug from the power harness to the front of the hitch and insert into the related connector.
3. Refer to standard hook-up procedures for the TS3 on page 26. After the trailer has been hooked-up to the trailer and the full weight is resting on the hitch, after 45-60 seconds SmartAir will automatically activate the compressor and inflate the hitch at or around the level indicator (see inflation techniques page 15).



**Figure 4.21 Inflation Line**



**Figure 4.22 SmartAir Level System (PN N/A)**

The air pressure that Smart Air maintains can be adjusted by moving the magnet on the slide bracket. If the magnet is adjusted further up, the air pressure will be reduced and if the magnet is adjusted further down the air pressure will be increased. To adjust magnet, loosen the screw holding it to the slide bracket, reposition and tighten screw. Smart Air will maintain a level that is approximately parallel to the dotted white line adjacent to the magnet.

4. Before unhooking, lower the trailer stabilizer jacks, taking the weight off the hitch. When the level indicator on the side of the hitch has risen 1 ½"-2", **wait 45-60 seconds** at this point the dump valve will open and

release all the air from the hitch. Follow the unhooking procedures found on page 27.

If the SmartAir system does not activate see page 35 for troubleshooting tips.

**NOTE: IMPORTANT**

Do not leave the 7-way pigtail attached to the truck and hitch, as this will draw power from the battery and result in battery loss!

### 4.2.3 Compressor with Built In Switch

Install the supplied power harness according to the instructions for Smart Air. The hitch will be inflated by pressing the button installed on the side of the hitch just beneath the Schrader valve (for proper levels follow standard inflation procedures page 15). To deflate follow standard deflations procedures found on page 15.

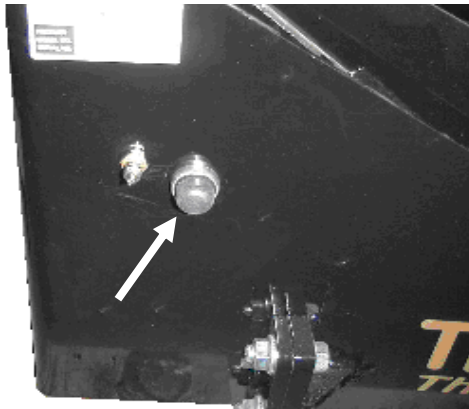


Figure 4.23 Manual Switch (PN 45421)

### 4.3 Installation of the TS3 Spacer Kit

If the TS3 is originally purchased with a spacer kit, it will already be installed on the hitch from the factory. If the TS3 has standard feet (14" operational height), use the following procedure for installing a spacer kit.

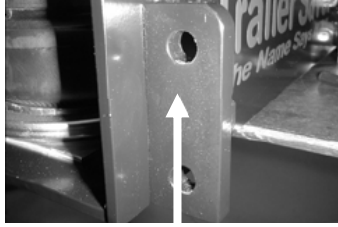
Check the contents of your package and make certain that your kit includes the following:



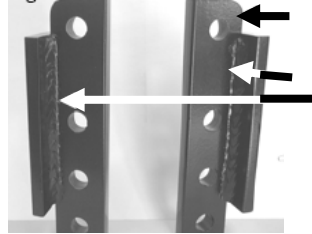
- 2 - riser supports
- 4 - riser legs
- 4 - 1/2" x 1 1/2" flanged bolts
- 4 - 1/2" flanged nuts

**Figure 4.24 Riser Kit (2"-PN 46250, 3"-PN 46350)**

5. Remove all 4 original bolted legs from the welded legs on the TS3 and keep the bolts and nuts to use with the riser.

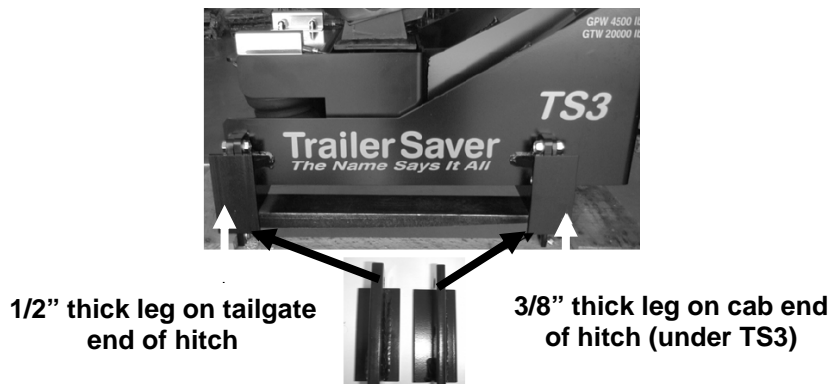


**Figure 4.25 Welded Leg**



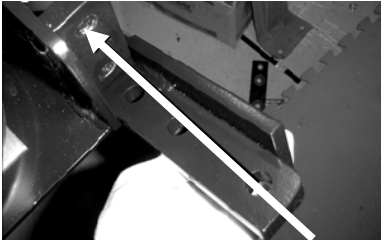
**Figure 4.26 Rounded Edge Up Long Weld Faces Outside**

6. Examine the riser legs in your kit.
7. All 4 are different and must be placed according to instructions. Each leg has a "long weld" side and a "short weld" side. The "short weld" will always be placed on the inside, against the welded leg and then bolted on.



**Figure 4.27 Placement of 1/2" and 3/8" thick legs**

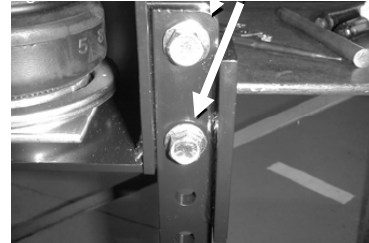
8. Also notice that 2 of the legs are 1/2" thick and the other 2 are 3/8" thick. The thicker pair will be bolted to the "tailgate end" legs and the thinner pair to the "cab end" legs.
9. Prepare to install by laying one cross support in front and one in back of hitch. Place each of the riser legs on their corner, looking at the hitch as follows:
  - Tailgate End Left—1/2" thick, short weld on bottom facing hitch
  - Tailgate End Right—1/2" thick, short weld on bottom facing hitch
  - Cab End Left—3/8" thick, short weld on bottom facing hitch
  - Cab End Right—3/8" thick, short weld on bottom facing hitch



**Figure 4.28** Riser installed In front of Hitch

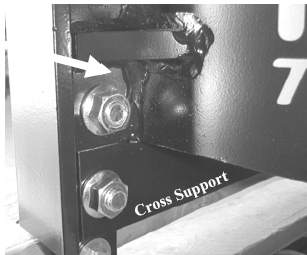


**Figure 4.29** Placed on each Corner of the hitch

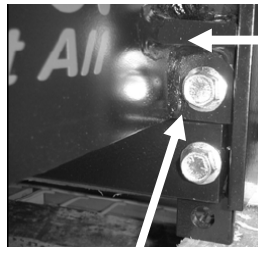


**Figure 4.30** Bolt head on the riser leg

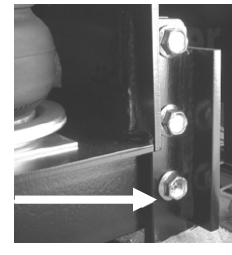
10. Using the bolts that were removed from the original legs, bolt the riser leg to the welded leg matching the top 2 holes.
11. The bolt heads should be on the riser leg and the nut should be tightened on the welded leg.
12. Repeat for all legs.



**Figure 4.31** Cross Support



**Figure 4.32** Welded Leg



**Figure 4.33** Riser Leg

**NOTE:**

**IMPORTANT**

The cross support needs to be placed directly under the welded leg, NOT the riser leg.

13. Place the cross support directly under the welded legs, matching cross support holes with riser leg holes, bolt together with one of the kit supplied flange bolts and nuts. Remember to keep the bolt end on the riser leg side and tighten the nut on the welded leg side.
14. Repeat this procedure for the other 3 legs

Once the riser legs and supports have been installed the hitch is ready for use.

## 4.4 SaverSlide/SimpleSlide Installation

Refer to page 14 for TS3 standard installation and operation for reference. SaverSlide is delivered fully assembled and may be installed in one or two pieces.

For one piece installation follow these steps:

1. Loosen the two bolts at each corner of the slider and set the entire unit into the outer slots of the rails and tighten each bolt to 50 ft-lbs. Insert hitch pins through bottom of rail and through each leg of slider frame.



Figure 4.34 Slider frame Bolts



Figure 4.35 7-Way power Harness (PN 41010)



Figure 4.36 Tee Fitting (PN 49212)

2. Refer to page 29 for SmartAir operation and plug the supplied power harness into the truck and the two-prong connector into the related plug inside the hitch.

For two-piece installation:

3. Remove the 4 pins holding the TS3 into the slider frame.
4. Disconnect the airline from the hitch to the slider frame. This can be accomplished by disconnecting either tee located at the front of the hitch
5. Remove TS3 from slider frame and set aside.
6. Loosen the two bolts at each corner of the slider and set the entire unit into the outer slots of the rails and tighten each bolt to 50 ft-lbs. Insert hitch pins through bottom of rail and through each leg of slider frame.





**Figure 4.37 Slider Frame leg**

7. Set the TS3 back in the corresponding slots in the slider frame and reconnect the air line to the tee.
8. Follow step 2 of one piece installation.

For SimpleSlide installation refer to step 1 of one piece installation or remove the 4 pins holding the hitch into the slide frame, set aside, and install in two sections.

## **4.5 Gooseneck Adapter Installation**



**Figure 4.38 Gooseneck Installation (PN 45540)**

To install the gooseneck adaptor on either a TS3 or TSLB;

1. Unthread the nut from the pivot bolt,
2. Remove pivot bolt and replace with gooseneck adaptor.
3. Retighten the nut until the gooseneck adaptor is firm.

## 5 Standard Hooking and Unhooking Procedures



Figure 5.1 Handle(PN 45512) / Hook(PN 45514) Extension

Locate the handle/hook extension shipped with the hitch. Use this handle and hook extension to reach the hitch handle and spring loaded retaining pin from outside the truck bed. The hitch handle has 3 positions referred to as 8 o'clock, 9 o'clock "auto-lock", and 10 o'clock as if the hitch head were the face of a clock.



Figure 5.2 Eight o'clock Position

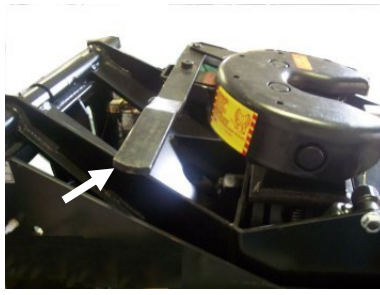


Figure 5.3 Nine o'clock Position

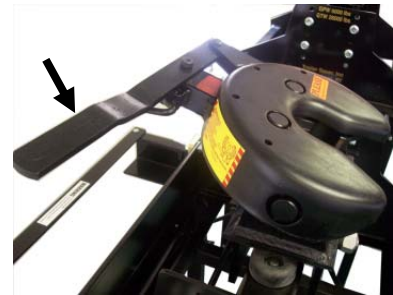


Figure 5.4 Ten o'clock Position

<b>NOTICE:</b>	<b>IMPORTANT</b>
The handle will be locked into the 8 o'clock position when the trailer is properly hooked up to a trailer and ready to tow. The hitch will be delivered in either the 10 or 9 o'clock positions.	

### 5.1 Hooking Up

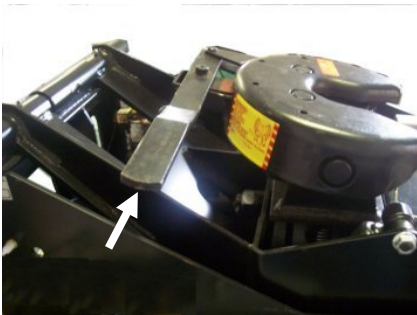


Figure 5.5 Before Hooking up (Nine o'clock)



Figure 5.6 Retainer Pin view at Eight o'clock



Figure 5.7 Padlock into Eight o'clock position

**NOTE: IMPORTANT**

Read carefully before and after hooking up.

4. Before hooking up, make sure the handle is at a 90 degree angle (9 o'clock) from the centerline of the hitch or in the auto-lock position.
5. Back the truck to the trailer until the kingpin just enters the "V" opening of the hitch.
6. Lower the trailer until the kingpin plate just makes contact with the hitch head; adding a small amount of air (10 #) may be needed to ensure good contact.
7. Back into the kingpin. The handle should be at the 8 o'clock position and the spring loaded retainer pin should be fully engaged behind the steel block.
8. Note: After every hook-up inspect the retaining pin to make sure it is engaged in the proper position, and push handle toward the cab to ensure it does not move out of the 8 o'clock position.

**NOTICE: IMPORTANT**

After every hook-up inspect the retaining pin to make sure it is engaged in the proper position, and push handle toward the cab to ensure it does not move out of the 8 o'clock position.

9. Raise trailer jacks and follow standard inflation procedures on page 15.
10. The hitch may be further secured in the 8 o'clock position with a padlock. This is inserted through an opening in the retainer pin housing that is only visible when the hitch is locked onto the kingpin.

**WARNING: IMPORTANT**

Always inspect for proper hook-up from a safe position that is not directly under the trailer!

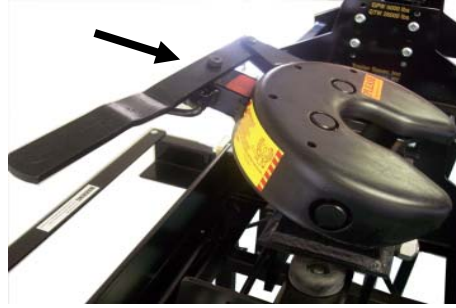
**NOTE: IMPORTANT**

For hook-up troubleshooting, refer to page 35.

## 5.2 Unhooking

1. Securely chock trailer wheels and lower trailer jacks, applying enough downward pressure to move the trailer up slightly.

2. Using the handle/hook extension pull out on spring loaded retainer pin and push handle toward the cab until it locks in the 10 o'clock position. The jaws should open but if there is pressure against the jaws they will remain closed even though the hitch is unlocked. If this happens, once the vehicle is moved a fraction, the jaws will unbind and spring open.
3. Lower the trailer jacks until the upward stops of the hitch have been reached or deflate the air springs. If this is not done, as the truck is pulled away from the trailer, the hitch will spring upward against the pin box with great force.
4. Drive away from the trailer.



**Figure 5.8 Ten o'clock position (note red mark is exposed)**

**NOTE:**

**IMPORTANT**

In the Ten o'clock position the red mark under the head is fully exposed.

### 5.3 Non Grease Lube Plates



**Figure 5.9 Non Grease Lube Plates (PN 46242)**

Many trailers are equipped with non-grease lube plates that are generally  $\frac{1}{4}$ " thick. The TrailerSaver may not engage around the kingpin if one of these standard lube plates is installed on the trailer. If the TrailerSaver does not lock around the kingpin following standard hook-up procedures, remove the standard lube plate and use grease or purchase a  $\frac{1}{8}$ " thick lube plate offered by Hensley Mfg.

## 6 SLIDER OPERATION

### 6.1 SaverSlide Operation

The operation of the SaverSlide includes a detailed review of the pneumatic and electronic connections in the following sections.



Figure 6.1 SaverSlide Operation

For a turn that requires the hitch to slide, **always** stop the truck. Do not slide the hitch while in motion. Press the unlock button on the key fob. With one hand holding the manual button on the brake controller to lock the trailer wheels, slowly pull the truck forward until the slider locks the hitch into the rear position. Release the manual control on the brake controller and the truck and trailer can now turn.

#### **WARNING:**

#### **IMPORTANT**

Never tow the trailer in the rearward/slid position at a speed greater than 10 MPH.

To move the hitch back into standard towing position, press the Lock icon on the key fob. With one hand holding the brake controller manual button, locking the wheels on the trailer, slowly back the truck until the hitch locks into the forward position on the slider.



Figure 6.2 Locking Mechanism

**Notice:**

Make sure the locking mechanism is engaged on both sides of the slider.

## Remote Sliding Quick Steps

**REAR POSITION**

1. Stop the truck
2. Press unlock button
3. Hold brake controller manual button to lock wheels
4. Slowly pull truck forward
5. Slider locks into the back position
6. Release brake controller
7. Transport at no more than 10 mph

**FORWARD POSITION**

1. Stop the truck
2. Press the lock button
3. Hold brake controller
4. Slowly back the truck
5. Slider locks into forward position
6. Release brake controller
7. Make sure locking mechanism is engaged

**WARNING:****IMPORTANT**

Make sure the locking mechanism is engaged on both sides of the slider.

Never slide the hitch while in motion.

Do not pull the trailer over 10 mph when the slider is in the rear position.

If the trailer is not in use for an extended period, unplug the pigtail from the truck and/or trailer connector.

**NOTE:****IMPORTANT**

There are three fuses inside the hitch.

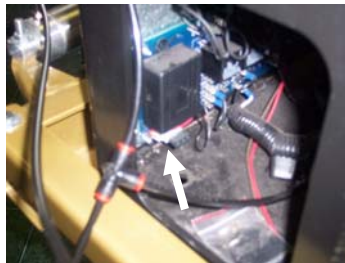


Figure 6.3 Fuse(s) Location

### 6.1.1 SaverSlide Pneumatic Connections

The next figure depicts the overall air flow throughout the system.

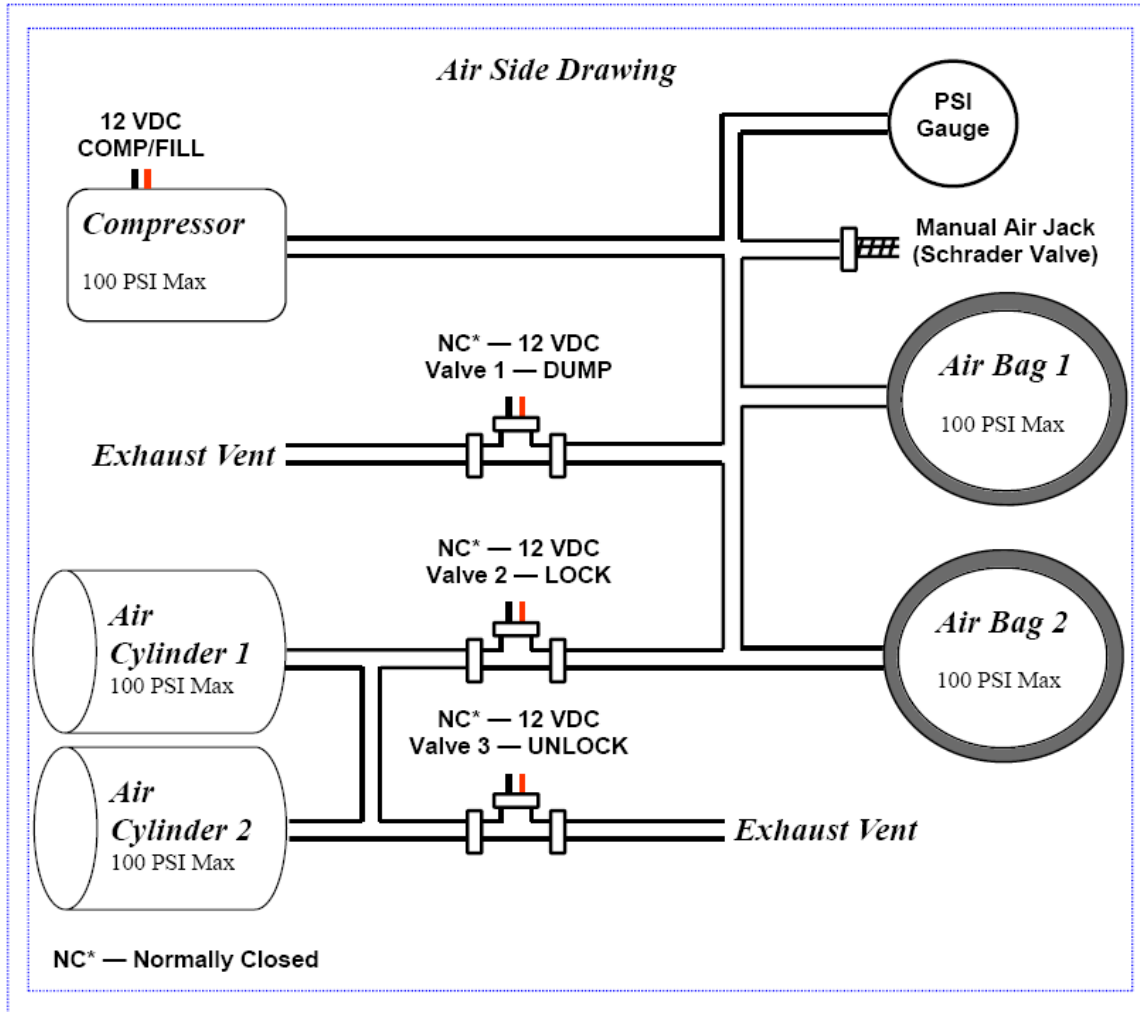


Figure 6.4 SaverSlide Air Side Drawing





**WARNING:****IMPORTANT**

Connecting spades to the wrong connection may damage your electronic circuit board and invalidate your warranty. Please confirm the connections with our tech support staff.

## 6.2 SimpleSlide Operation

This section refers to utilizing the SimpleSlide manually without the automatic air pressure feature and remote control.



Figure 6.7 Handle(PN 45512) / Hook(PN 45514) Extension

1. For a turn that requires the hitch to slide, stop the truck and locate the handle and hook extension. On the driver side of the truck, locate the retaining pin and release lever on the slide frame.



Figure 6.8 Retaining Pin location

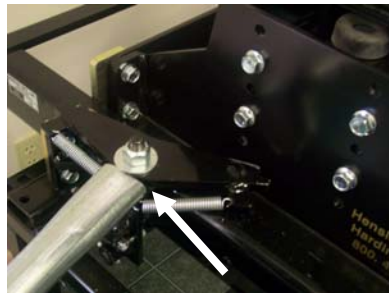


Figure 6.9 Locking mechanism



Figure 6.10 Turn tow vehicle position

2. Use the hook to pull outward on the retaining pin and use the handle extension to push release lever to the rear position, unlocking the hitch from the forward towing position.
3. After the locking mechanism is released the hitch may be slid to the rear position. With one hand on the manual button of the brake controller, slowly pull forward until hitch locks in the rear position.
4. At this point, the tow vehicle can be turned. To return hitch to standard forward position, reverse these steps.

**Notice:**

Never tow the trailer in the rear/slid position at a speed greater than 10 MPH.

Make sure locking mechanism is engaged on both sides of the slide frame.

## 7 Maintenance

1. Locate the two grease fittings located on top of the swing arm hinge on the front side of the hitch. Grease these fittings every 4,000 miles using high grade automotive grease.



Figure 7.1 Grease every 4,000 miles



Figure 7.2 Check pivot bolt wear (PN 44031)

2. Check pivot bolt, located directly under head to ensure the nut is tight and not worn. Inspect this bolt once a year for excessive wear. If the hitch has more than 1/8" vertical play the bolt should be replaced. Nut should be tightened just enough to put pressure on the head so that it will not freely move side to side.
3. Apply a spray lubricant to the following parts of the head:
  4. Side pivot pins located on both sides of the jaw opening.



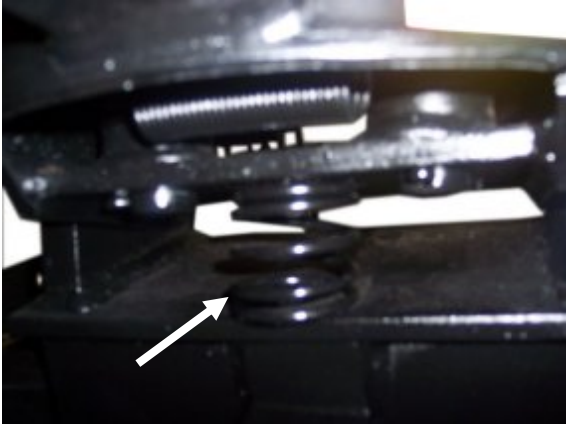
Figure 7.3 Fore/Aft Pivot Pins



Figure 7.4 Jaw Pivot pins location

**NOTE: IMPORTANT**  
Jaw pivot pins are located on top of head.

5. Spray the tilt spring from front and back of hitch.



**Figure 7.5 Tilt spring location (PN 44009)**



**Figure 7.6 Jaw mechanism**

6. Lubricate jaw mechanism front hitch opening.
7. Protect the air springs from UV rays. Air springs may be treated with a rubber treatment to prolong life. A vinyl hitch cover is also available through Hensley Mfg.

## 8 TROUBLESHOOTING

### 8.1 General Troubleshooting

#### 8.1.1 I cannot get the TrailerSaver to lock around the kingpin.

1. Check the handle and be sure it is in the 9 o'clock position.
2. Determine if the trailer has a standard ¼" lube plate; if so remove the lube plate and attempt hooking up again.
3. Inspect the kingpin to ensure there are no burrs or high spots. Should burrs be found, file it off and make sure the kingpin and hitch jaws are clean and free of any debris.

#### 8.1.2 The TrailerSaver will not hold air pressure.

1. Inflate hitch to substantial air pressure
2. Listen for a hissing sound and feel for air escaping from one of the fittings.
3. Spray the fittings with soapy water and look for spots that bubble up.
4. Locate the fitting that is leaking air, remove the air tube and trim the end then reinsert into the fitting.



Figure 8.1 Fittings check with soapy water (PN 45003, PN 49209, PN 45554 and PN 49212)

#### 8.1.3 I hear a squeak from the hitch.

Spray a lithium-based lubricant into the two fore and aft pivot pins located on both sides of the hitch coupler.



Figure 8.2 Lubricate fore and aft pivot pins

### **8.1.4 I cannot get the handle from the 10 o'clock position to the 9 o'clock position.**

Grab the hitch handle and push further toward the cab. The hitch should have some slack in the handle, by pushing toward the cab pressure will be relieved from the spring loaded safety pin and it will pull out with ease allowing the handle to move to the 9 o'clock position.

### **8.1.5 The TS3 will not fit into the rails.**

Make sure the 4 square legs are only attached to the hitch finger tight. After inserting the 4 legs in the rails, then torque the two bolts down. (See installation page 14).

### **8.1.6 I am getting a rough ride.**

1. Check the air pressure with the trailer attached. Hitch should be filled just until the white line is even or above the outer frame.
2. Make sure the trailer load is properly balanced. A trailer with too little pin weight or one that is back-heavy for the overall weight will cause erratic up and down movement at the hitch.
3. For very heavy trailers, make sure air pressure does not exceed 100 PSI in the air springs. If the pressure does exceed 100 PSI the tongue weight is too heavy for the hitch. For TSLB the 3<sup>rd</sup> airbag kit may be added to reduce air pressure and provide a smoother ride.

## **8.2 For SmartAir and SaverSlide**

### **8.2.1 When I hook up to the trailer the compressor does not activate.**

1. Make sure the full weight of the trailer is resting on the hitch.
2. Wait 40 seconds for the compressor to turn on.
3. Check the 20A twin blade fuse located along the harness that goes to the compressor located inside the hitch. If the fuse is blown it should be replaced.
4. Check with the truck manufacturer to ensure the fuse for the 12 v + lead to the 7-way plug is in the appropriate position (some manufacturers leave this un-fused or unhooked at the fuse box from the factory). Also make sure this fuse is not blown.
5. Inspect the magnet that is attached to the slide bracket. Make sure the magnet is slid below the dotted white line on the module and the small orange dot on the face of the magnet is facing the module.
6. Inspect for severed wires.



Figure 8.3 Fuse Location



Figure 8.4 SmartAir Level

## 8.3 SaverSlide

### 8.3.1 When I press the key fob remote, the slider locks do not activate.

1. Inspect the airbags to ensure the SmartAir system is pressurizing the air springs. If the air springs are not pressurized, the pneumatic cylinders will not activate the locks.
2. Make sure the hitch has slid all the way to the forward-most or rearward-most stopping point. If unsure, simply press the manual button on the brake controller and accelerate slightly to ensure the locks are not bound and within the proper tolerance to activate.
3. Inspect the air system to ensure it is maintaining a consistent air pressure. If the hitch has a fast leak the pneumatic cylinders will not have enough pressure to operate properly.
4. Verify the hitch is receiving a consistent 12 volts from the pigtail harness. (If the hitch is receiving electricity, a red LED on the circuit board should be illuminated.)

### 8.3.2 I have power to the 2-prong connector but the hitch does not inflate.

Check all three fuses inside hitch. One fuse is located on the circuit board just below the black box, the second is in line with a group of wires coming from the circuit board, and the third is in-line with the bundle of wires next to the compressor and wrapped in wire loom.



Figure 8.5 Remote control fuse location



Figure 8.6 Inline fuse location



Figure 8.7 Wire loom fuse location

## 9 Accessories

Hensley Mfg. offers several accessories for your TrailerSaver hitch.

Vinyl Hitch Covers for TSLB and TS3



**Figure 9.1 Vinyl Hitch Cover (PN 45571)**

Gooseneck Adapter Ball - Simply unbolt head and replace with Gooseneck adaptor



**Figure 9.2 Gooseneck adapter ball (PN 45540)**

Emergency Kit - Spare parts kit in case of emergency



**Figure 9.3 Emergency Kit (PN 45600)**

Lube Plate - For use in place of standard 1/4" lube plate



**Figure 9.4 Lube Plates (PN 46242)**

Ultimate Tire Chock - A better solution for stabilizing trailer wheels



**Figure 9.5 Ultimate Tire Chock (PN 40050)**





